



# AC-FRESCO-4X

User manual

2x2 8K Video Wall Processor

# Contents

Important Safety Instructions .....	4
Safety Classifications in this Document.....	4
Electrical Shock Prevention.....	4
Weight Injury Prevention.....	4
Safety Statements .....	5
Introduction .....	6
Features.....	6
Product Overview .....	7
Box Contents .....	7
Technical Specifications.....	7
Front and Rear Panel Overview.....	8
Installation.....	10
Rack Mounting.....	10
Wiring and Connections .....	10
HDMI Cables .....	10
USB Ports .....	10
Ethernet/LAN .....	10
RS-232 Control.....	11
Balanced Audio Output Port.....	12
AC Power Connection .....	12
Initial Setup .....	12
Connecting Devices.....	12
Navigating the Web UI .....	13
Video Wall Configuration.....	14
Area Offset (Cropping).....	14
Area Scaling (Scaling).....	15
Area Scandir (Mirroring).....	15
Bezel compensation .....	15
I/O Config .....	16
Input Settings.....	16
Video Output Settings .....	17
System .....	18
IP Settings .....	18
IP Control .....	19
Admin Web Interface.....	19

User Web Interface .....	19
Hardware .....	20
Cloud Services and Firmware Updates .....	20
Console.....	23
Command-List .....	24
Troubleshooting .....	26
Maintenance .....	26
Damage Requiring Service .....	26
Support.....	26
Warranty.....	27
The Basics.....	27
Coverage Details .....	27
Red Tape.....	27
Obtaining an RMA .....	27
Shipping.....	28
Limitation on Liability .....	28
Exclusive Remedy.....	28

# Important Safety Instructions

Before installing, configuring, and operating this device and other vendor equipment, AVPro Edge strongly recommends that each dealer, integrator, installer, and all other necessary personnel access and read all the required technical documentation, which can be located by visiting [AVProEdge.com](http://AVProEdge.com).

**Read and understand all safety instructions, cautions, and warnings in this document and the labels on the equipment.**

## Safety Classifications in this Document

■ <b>Note:</b>	Provides special information for installing, configuring, and operating the device with equipment.
✦ <b>Tip:</b>	Provides suggestions and considerations for installing, configuring, and operating the device with equipment.
▲ <b>Important:</b>	Provides special information critical for installing, configuring, and operating the device with equipment.
▲ <b>Caution:</b>	Provides special information to avoid situations that may cause damage to the device and other equipment.
▲ <b>Warning:</b>	Provides special information for avoiding situations that may cause physical danger to the installer, end-user, etc.

## Electrical Shock Prevention

▲ <b>Electric Shock:</b>	Provides special information critical for installing, configuring, and operating the devices and equipment.
▲ <b>Electrical Disconnect:</b>	Provides special information to avoid situations that may cause damage to the devices and equipment.

## Weight Injury Prevention

▲ <b>Weight Injury:</b>	Two installers may be required to ensure safe handling during the installation of some devices and equipment. Failure to use two installers may result in injury.
-------------------------	---

## Safety Statements

Follow all of the safety instructions listed below and apply them accordingly. Additional safety information will be included where applicable.

- 1 Read and keep these instructions.
- 2 Heed and follow all warnings.
- 3 Clean devices and equipment only with a dry cloth.
- 4 Do not use the devices near water or expose them to rain and moisture.
- 5 Do not block any ventilation openings.
- 6 The devices and accessories should never be exposed to flames or excessive heat.
- 7 Only use attachments and accessories specified by the manufacturer.
- 8 Install in accordance with the manufacturer's instructions.
- 9 Do not install near any heat sources, such as radiators, heat registers, stoves, or other heat apparatus.
- 10 Do not defeat the safety purpose of the polarized / grounding-type plug. A polarized plug has two blades, one wider than the other. A grounding-type plug has two blades and a third grounding prong. The wide blade, or third prong, is provided for your safety.
- 11 Protect the power cord from being walked on or pinched, particularly at plugs, convenience receptacles, and where they exit from the devices.
- 12 Unplug the devices during lightning storms or when unused for long periods.
- 13 Never handle or touch the devices and power cord with damp hands to reduce the risk of electrical shock or damage to them and their operators.
- 14 To reduce the risk of injury, some devices and equipment may require two installers to ensure safe handling during installation. Failure to use two installers may result in injury.
- 15 Refer all servicing to qualified service personnel. Servicing is required when the devices have been damaged in any way, such as the power cord or plug, liquid spilled, objects fallen into the devices, exposed to rain or moisture, do not operate normally, or have been dropped.

# Introduction

The AC-FRESCO-4X is a 48 Gbps 8K 2x2 video wall processor. The unit supports one HDMI source up to 8K/60 Hz 4:2:0 / 4K/120 Hz 4:4:4 with four HDMI outputs capable of 4K/60 Hz 4:4:4. High Frame Rate and Variable Refresh Rate support enables the AC-FRESCO-4X to process signals from next-gen gaming consoles and gaming PCs for stable video wall performance. This video wall processor features powerful but easy-to-use cropping and scaling, controlled by an intuitive web interface and the front panel display. Audio embedding enables extraction from HDMI source content for output to an AVR or surround sound processing.

The diagram below shows the basic application of the AC-FRESCO-4X:

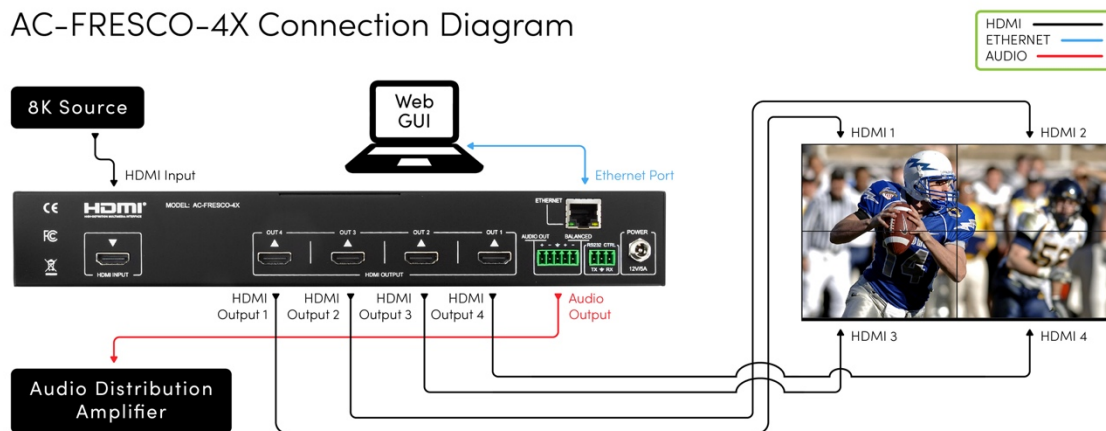

## Features

- HDMI sources up to 48 Gbps 8K/60 Hz with HDR
- Web interface and front panel for quick deployment and easy maintenance
- Variable to fixed refresh rate scaling to support latest generation gaming consoles or PCs
- Advanced EDID management contends legacy display or mixed-display videowall issues
- Scaling, cropped, and bezel compensation to customize video wall output
- Audio de-embedding for balanced audio extraction to external audio and surround sound systems
- RS-232 interface for control system integration

# Product Overview

## Box Contents

- (1x) AC-FRESCO-4X 2x2 Video Wall Processor
- (2x) 1RU Rack Mounting Brackets
- (6x) Screws for Mounting Brackets
- (1x) 5-Pin Euroblock Connector
- (1x) 3-Pin Euroblock Connector
- (1x) 12 VDC Locking Power Supply

## Technical Specifications

<b>Video Input</b>	
Video Resolutions	Up to 8K/60 Hz 4:2:0, 4K/120 Hz 4:4:4
HDR Formats	HDR10, HLG
Color Space	YUV (Component), RGB (CSC: ITU-R BT.601, ITU-R BT.709, ITU-R BT.2020, DCI-P3 D65)
Chroma Subsampling	4:4:4, 4:2:2, 4:2:0
Deep Color	Up to 16-bit
Scaling	Auto, Force 4K, Force 1080p
HDCP	HDCP 2.3 and earlier
<b>Video Output</b>	
Video Resolutions	Up to 4K/60 Hz
HDR Formats/Resolutions	HDR10, HLG
Color Space	YUV (Component), RGB (CSC: ITU-R BT.601, ITU-R BT.709, ITU-R BT.2020, DCI-P3 D65)
Chroma Subsampling	4:4:4, 4:2:2, 4:2:0
Deep Color	Up to 16-bit
Scaling	Auto, Force 4K, Force 1080P
HDCP	HDCP 2.3 and earlier
<b>Audio</b>	
Audio Formats Supported by HDMI	PCM 2.0-Ch., LPCM 5.1 & 7.1, Dolby Digital, Dolby Digital Plus, Dolby TrueHD, Dolby Atmos, DTS 5.1, DTS-HD Master Audio, DTS:X
Audio Formats Supported Extracted (2-Ch. Port)	PCM 2.0-Ch.
<b>DISTANCE</b>	
HDMI In/Out	Up to 13 ft. (8K/30 Hz) or 49 ft. (4K/120 Hz)**
HDMI In/Out (w/ AOC Cable)	Up to 130 ft. (4K/60 Hz, 18 Gbps AOC)**
<b>control</b>	
Front Panel	LCD Screen with 4-button navigation
Ports	LAN, RS-232, USB-C
Web Interface	Yes
<b>Ports</b>	
HDMI	Type-A
LAN	RJ45 w/ Web Interface
Audio (Extracted Analog)	5-pin Euroblock (Balanced)
RS-232	3-pin Euroblock
ISP/CTL	USB-C
<b>Environmental</b>	

Operating Temperature	23° to 125° F (-5° to 51° C)
Storage Temperature	-4° to 140° F (-20° to 60° C)
Humidity Range	5% to 90% RH (No Condensation)
<b>Power</b>	
Power Consumption (Total)	40 W Maximum
Power Supply	Input: 100-240 VAC ~ 50/60 Hz Output: 12 VDC, 5 A
<b>Physical / Dimensions</b>	
Mounting	1-RU Rack Mounting Brackets Rubber Feet
Dimensions (Unit Length/Width/Height)	mm: 136.652 X 295.402 X 45.212 in: 5.38 X 11.625 X 1.781
Dimensions (Packaged Length/Width/Height)	mm: 219.075 X 388.950 X 65.1 in: 8.625 X 15.313 X 2.563
Weight (Unit)	2.875 lbs. (1.3041 kg)
Weight (Packaged)	4.394 lbs. (1.9931 kg)
Regulatory	CE/FCC
Product Warranty	10 Years
*Specifications are subject to change without notice. Mass and dimensions are approximate. **Distances achieved with Bullet Train HDMI and AOC cables.	

## Front and Rear Panel Overview

### Front Panel

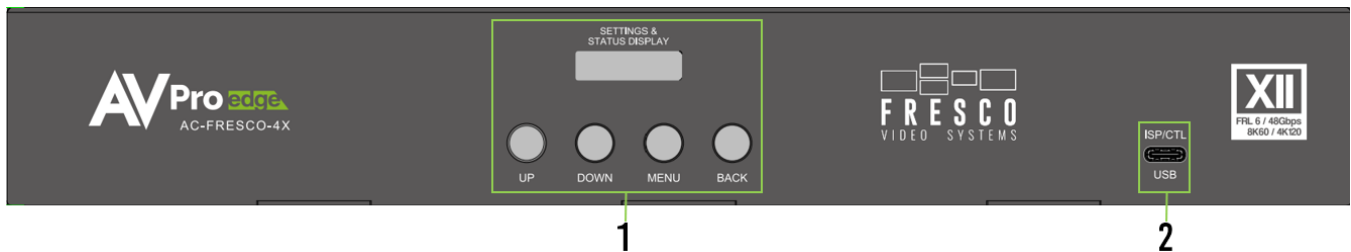

### Rear Panel

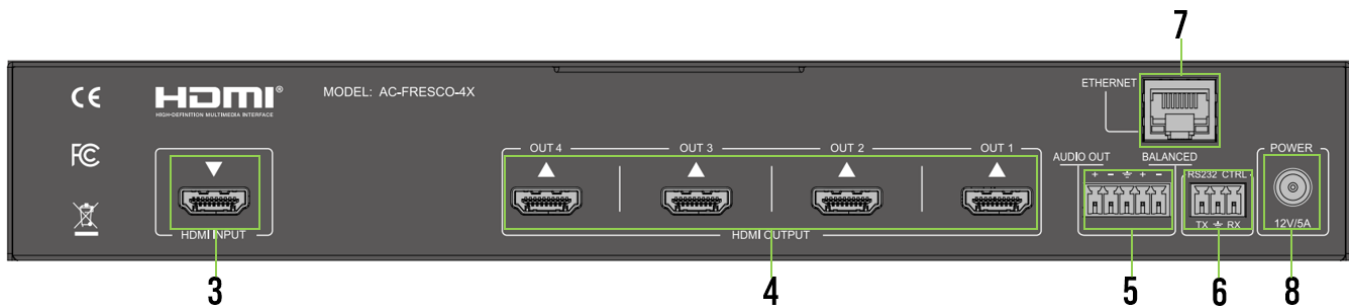

- |  |  |
|--|--|
| <b>1 Front Panel with 4-button control</b> | <ul style="list-style-type: none"> <li>• Front panel display for settings and status</li> <li>• Up, Down, Menu, and Back buttons for navigation</li> <li>• IP settings and EDID can be changed from the front panel</li> </ul> |
| <b>2 ISP / CTL USB-C</b>                   | <ul style="list-style-type: none"> <li>• USB Type-C female connector port</li> <li>• Servicing port for AVPro Edge Technical Support</li> </ul>  |
| <b>3 HDMI Input</b>                        | <ul style="list-style-type: none"> <li>• 19-pin HDMI Type-A female connector port</li> <li>• Source input with HDMI connection</li> </ul>  |

---

<b>4</b>	<b>HDMI Output (1-4)</b>	<ul style="list-style-type: none"><li>• (4x) 19-pin HDMI Type-A female connectors</li><li>• Downscales incoming 8K signal to four separate HDMI outputs for video wall displays</li></ul>
<b>5</b>	<b>Balanced Audio Output</b>	<ul style="list-style-type: none"><li>• 5-pin Euroblock connector port</li><li>• Balanced stereo audio output</li></ul>
<b>6</b>	<b>RS232 CTRL</b>	<ul style="list-style-type: none"><li>• 3-pin Euroblock connector port</li></ul>
<b>7</b>	<b>Ethernet</b>	<ul style="list-style-type: none"><li>• 8-pin RJ45 female connector</li><li>• Web interface access for control and maintenance</li></ul>
<b>8</b>	<b>Power In</b>	<ul style="list-style-type: none"><li>• Barrel connector</li><li>• 12 VDC / 5 A power input</li></ul>

---

# Installation

## Rack Mounting

The AC-FRESCO-4X is one RU in height and may be mounted in any compatible standard 19-inch wide enclosure. Two mounting brackets are included with the unit.

- 1 Align the holes on the mounting brackets with the holes on both sides of the rack.
- 2 Attach the mounting brackets to the rack with rack screws (not included).

## Wiring and Connections

### HDMI Cables

The AC-FRESCO-4X uses standard 19-pin HDMI female ports for input and output connections.



Important things to consider when planning or installing this device:

- Ensure all HDMI cables and devices support the input signal. With 8K sources, ultra-high-bandwidth/Ultra High Speed HDMI cables rated for 48 Gbps are recommended. For 4K and lower resolutions, High-Speed HDMI cables with Ethernet rated for 18 Gbps are sufficient if all connected devices are rated to handle the signal.
- Ensure HDMI cables are the correct length. AVPro engineers have determined that HDMI cables 2 meters and longer help eliminate EDID and HDCP issues associated with shorter HDMI cable lengths.

### USB Ports

The device has one USB Type-C port. This is a service port intended for AVPro Edge technical support if troubleshooting or testing is required.



Type-C

### Ethernet/LAN

The NETWORK/LAN port on the rear panel communicates with the AC-FRESCO-4X via a LAN, router, or third-party control system processor and uses a standard RJ45 connector plug.



The recommended termination is based on the TIA/EIA T568A or T568B standards for the wiring of the twisted pair cables. For TCP/IP control, commands use Telnet port 23.

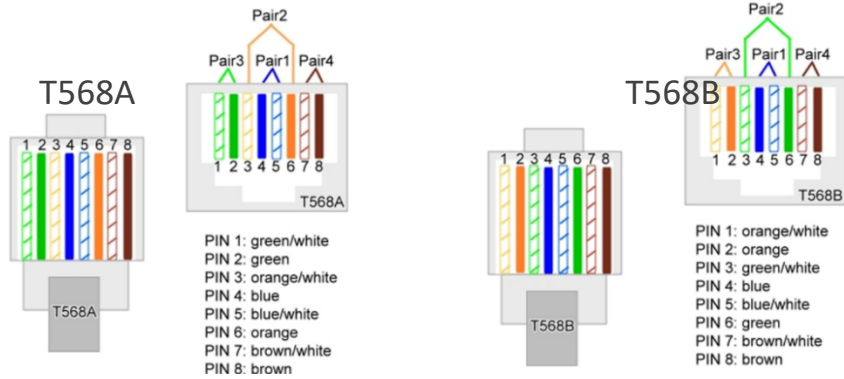

## RS-232 Control

The RS-232 control port on the rear panel allows a computer or third-party control system to communicate with the AC-FRESCO-4X.

Serial control connections are made using the provided 3-pin Euroblock connector. Insert the wire into the appropriate hole, then secure it by tightening the screw located at the top of the connector.



Wiring for this port uses a 3-pin Euroblock-to-DB9 connector, where only pins 2, 3, and 5 are used. If the control devices do not have a DB9 port, a USB-to-DB9 adapter may be required.

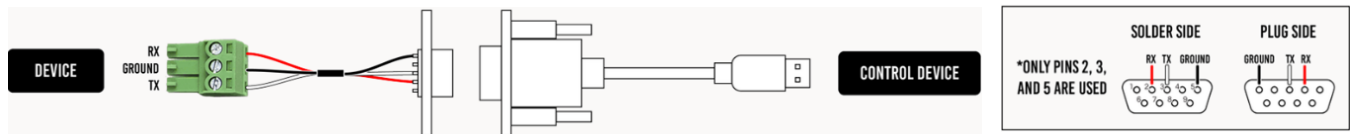

For RS-232 control, use a null modem serial cable adapter and set the serial communications to: Baud: 57600, no parity, 8 data bits, 1 stop bit, with no handshaking.

Add a carriage return (Enter key) after each command when using direct commands. The unified command list (ASCII) can be found here.

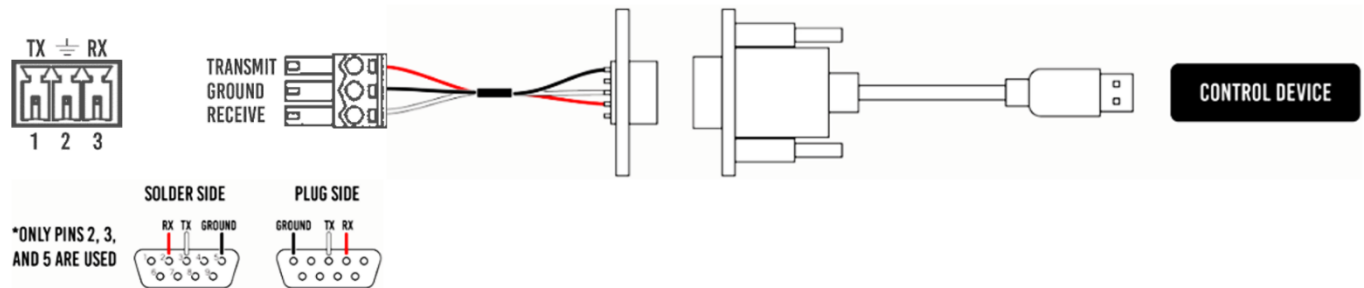

# Balanced Audio Output Port

The AC-FRESCO-4X has one 5-pin Euroblock balanced audio output port.

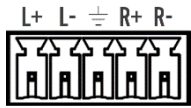

## AC Power Connection

- ▲ **Electric Shock:** Use a surge-protected circuit for all components and power supplies.
- ▲ **Electrical Disconnect:** The power source outlet and power supply input sockets should be easily accessible to disconnect power in the event of an electrical hazard or malfunction.

## Initial Setup

Use the steps below to connect physically to the input and output devices. For the initial setup, once all the physical connections are made, connect the AC-FRESCO-4X to a LAN (Local Area Network) using a control PC on the same network and then access the Web UI.

## Connecting Devices

- 1 Connect an HDMI input source to the HDMI INPUT connector on the rear of the AC-FRESCO-4X.

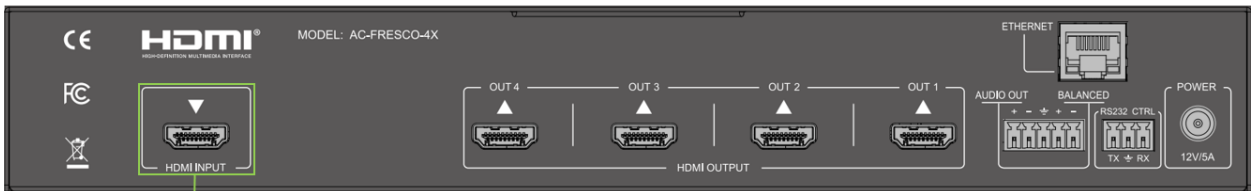

Connect HDMI Input

- 2 Connect video wall HDMI display cables to the HDMI OUTPUTS on the rear of the AC-FRESCO-4X.

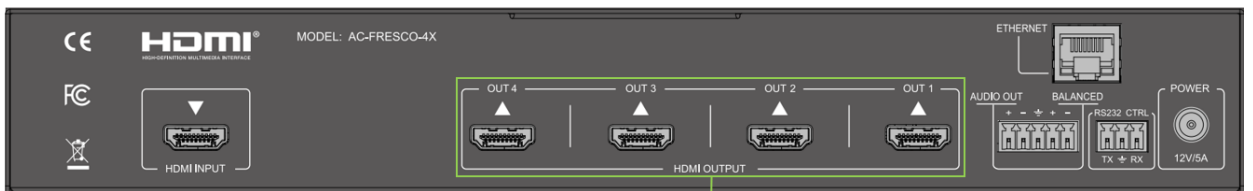

Connect HDMI Outputs

Connect an RJ45 cable from the ETHERNET port of the AC-FRESCO-4X to the LAN or a PC.

Connect LAN

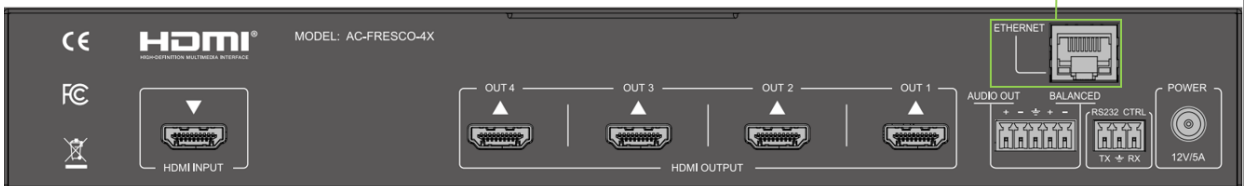

- 3 Power on the source connected to the HDMI INPUT port.
- 4 Power on the video wall displays connected to the HDMI OUTPUT ports.

- 5 Connect the 12 VDC power supply to the POWER input port on the rear of the AC-FRESCO-4X and plug it into a suitable power source.

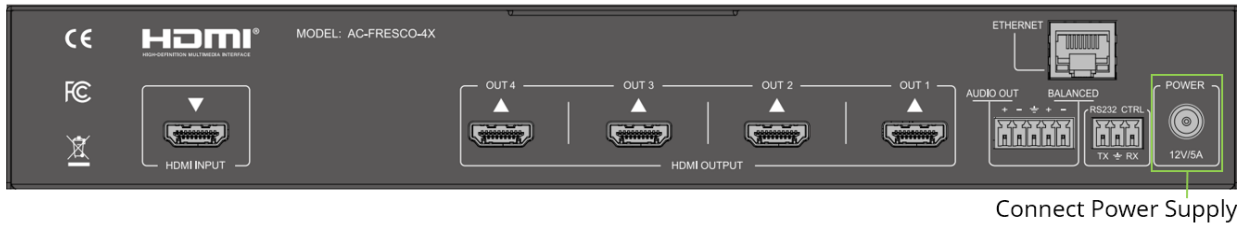

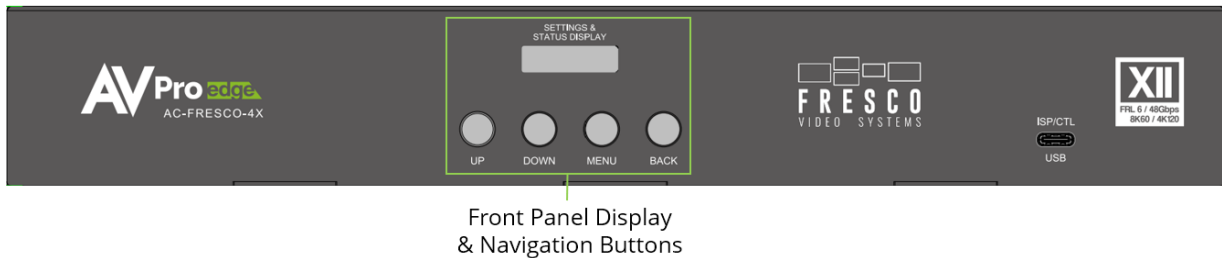

- 6 To check the current IP settings, use the front panel display and buttons to navigate to the NET menu option. Press MENU, DOWN, and then MENU for IP settings.

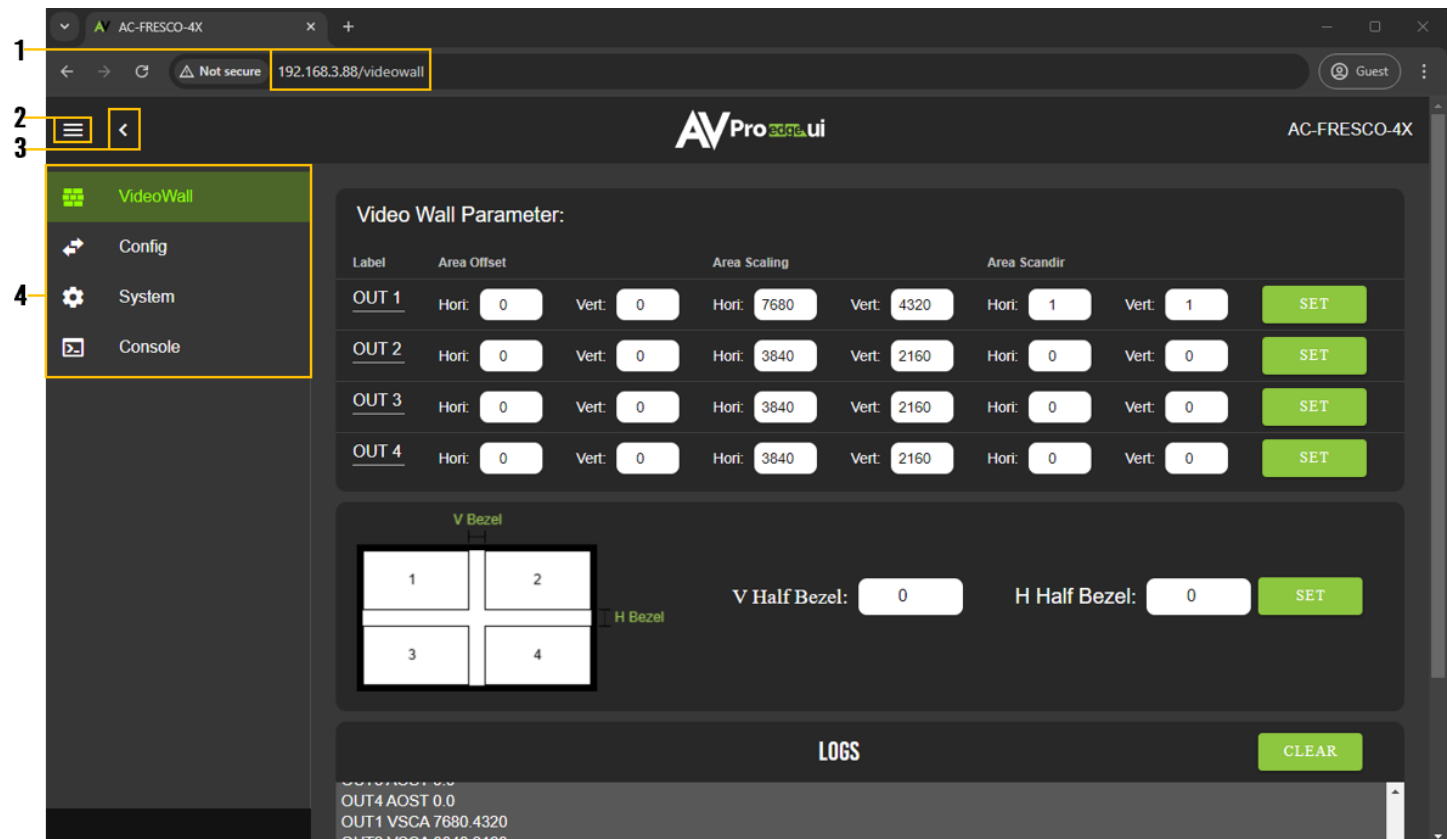

## Navigating the Web UI

The AC-FRESCO-4X features a built-in User Interface (UI) that can be accessed through a web browser for configuration and control. Different tools and settings can be selected from the tab pages on the navigation menu column on the left side of the screen.



- 2 To hide the navigation menu, select the *hamburger* menu icon .
- 3 Select the *left arrow* icon to hide the navigation menu text and show only the menu icons .
- 4 Select the individual tab pages from the navigation menu to navigate through the different pages. This will highlight the tab page in green to indicate the currently selected page.

## Video Wall Configuration

The **Video Wall** page layout consists of scaling, cropping, and mirroring settings for the four HDMI outputs and display bezel compensation. Each output has horizontal and vertical values to manipulate the aspect ratio parameters for each video output.

**Video Wall Parameter:**

Label	Area Offset		Area Scaling		Area Scandir		
<u>OUT 1</u>	Hori: <input type="text" value="0"/>	Vert: <input type="text" value="0"/>	Hori: <input type="text" value="7680"/>	Vert: <input type="text" value="4320"/>	Hori: <input type="text" value="1"/>	Vert: <input type="text" value="1"/>	<input type="button" value="SET"/>
<u>OUT 2</u>	Hori: <input type="text" value="0"/>	Vert: <input type="text" value="0"/>	Hori: <input type="text" value="3840"/>	Vert: <input type="text" value="2160"/>	Hori: <input type="text" value="0"/>	Vert: <input type="text" value="0"/>	<input type="button" value="SET"/>
<u>OUT 3</u>	Hori: <input type="text" value="0"/>	Vert: <input type="text" value="0"/>	Hori: <input type="text" value="3840"/>	Vert: <input type="text" value="2160"/>	Hori: <input type="text" value="0"/>	Vert: <input type="text" value="0"/>	<input type="button" value="SET"/>
<u>OUT 4</u>	Hori: <input type="text" value="0"/>	Vert: <input type="text" value="0"/>	Hori: <input type="text" value="3840"/>	Vert: <input type="text" value="2160"/>	Hori: <input type="text" value="0"/>	Vert: <input type="text" value="0"/>	<input type="button" value="SET"/>

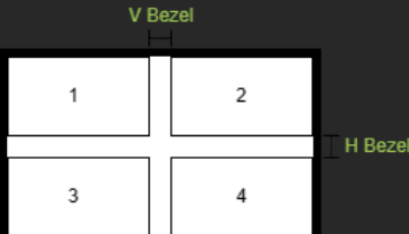

V Half Bezel:

H Half Bezel:

### Area Offset (Cropping)

Enter the Horizontal (Hori) and Vertical (Vert) values or use the Up/Down arrows in the dialog boxes to adjust the image displayed from an HDMI output and to crop the image to the desired horizontal and vertical values. To apply these settings, click the SET button.

**Video Wall Parameter:**

Label	Area Offset		Area Scaling		Area Scandir		
<u>OUT 1</u>	Hori: <input type="text" value="0"/>	Vert: <input type="text" value="0"/>	Hori: <input type="text" value="7680"/>	Vert: <input type="text" value="4320"/>	Hori: <input type="text" value="1"/>	Vert: <input type="text" value="1"/>	<input type="button" value="SET"/>

## Area Scaling (Scaling)

Enter the Horizontal (Hori) and Vertical (Vert) values or use the Up/Down arrows in the dialog boxes to adjust the resolution of the selected area for display on an HDMI output. These settings scale the image to the desired horizontal and vertical values. To apply these settings, click the SET button.

Video Wall Parameter:

Label	Area Offset	Area Scaling	Area Scandir
OUT 1	Hori: 0 Vert: 0	Hori: 7680 Vert: 4320	Hori: 1 Vert: 1

SET

## Area Scandir (Mirroring)

Enter 0 or 1 in the Horizontal (Hori) and/or Vertical (Vert) dialog boxes or use the Up/Down arrows to adjust the image mirroring on the HDMI output.

- A value of 1 will mirror the image 180 degrees along the corresponding axis (horizontal or vertical).
- A value of 0 turns off the image mirroring.

To apply these settings, click the SET button.

Video Wall Parameter:

Label	Area Offset	Area Scaling	Area Scandir
OUT 1	Hori: 0 Vert: 0	Hori: 7680 Vert: 4320	Hori: 1 Vert: 1

SET

## Bezel compensation

Bezel compensation settings on the AC-FRESCO-4X adjust the displayed content to appear seamless across multiple screens, accounting for the physical borders (bezels) of the monitors/displays in the video wall.

To configure bezel compensation:

- 1 Use a ruler or calipers to accurately measure the physical width of the bezel (the gap between two adjacent displays) in millimeters.
- 2 Divide this measurement in half.
- 3 Enter the resulting value into the V Half Bezel or H Half Bezel dialog boxes, depending on the vertical or horizontal alignment of the four displays.
- 4 To apply these settings, click the SET button.

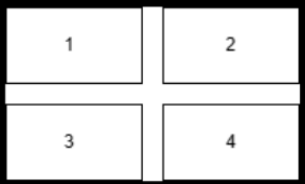

The diagram shows a 2x2 grid of displays labeled 1, 2, 3, and 4. A vertical line between displays 1 and 2 is labeled 'V Bezel', and a horizontal line between displays 1 and 3 is labeled 'H Bezel'.

V Half Bezel: 0

H Half Bezel: 0

SET

# I/O Config

The **Config** tab page features tools and settings for configuring HDMI inputs and outputs.

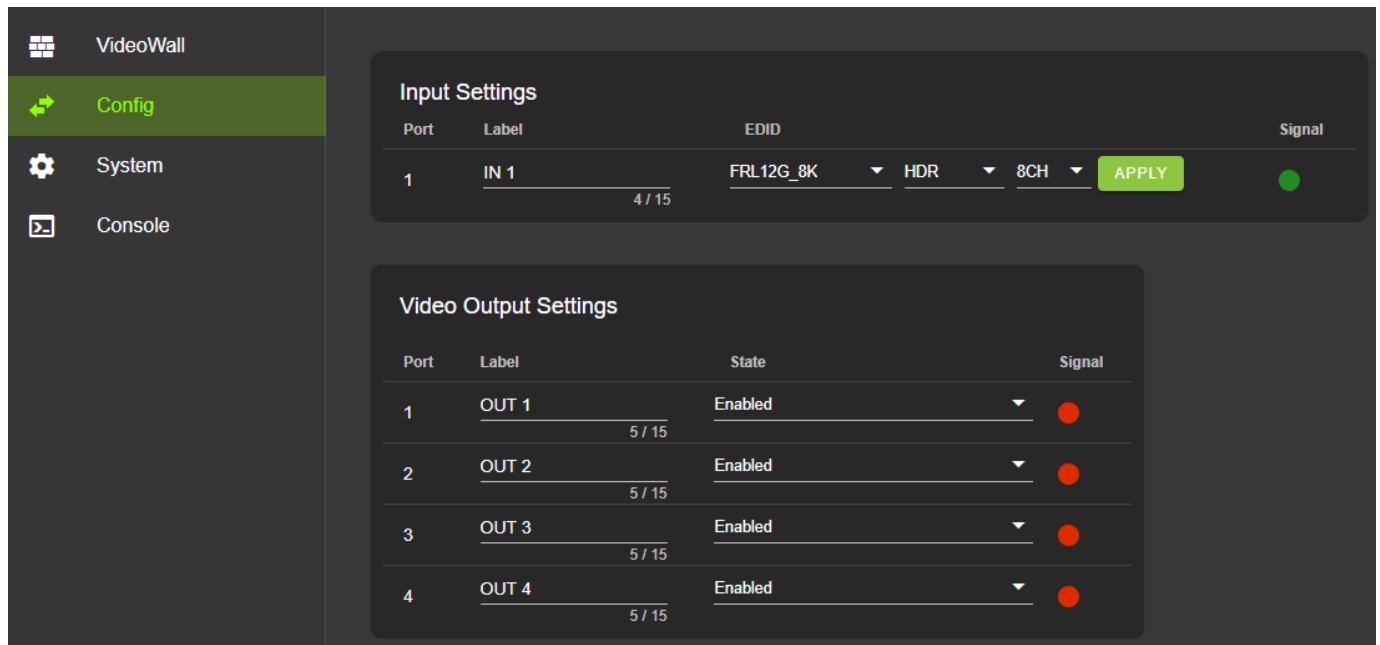

## Input Settings

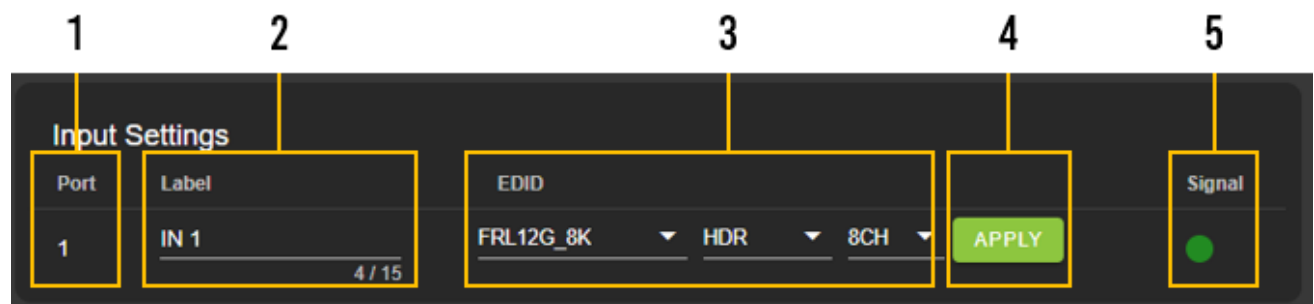

1	Port	Indicates the HDMI input port number.
2	Label	Select the text field to enter a custom name for the input. <i>(Limited to 15 characters)</i>
3	EDID	Select the EDID from the drop-down menu. The first drop-down group configures resolution and refresh rate. The second drop-down group shows the HDR dynamic range. The third drop-down group configures the audio channels with 2CH, 6CH, and 8CH options. <b>NOTE:</b> When selecting USER1, USER2, or USER3 EDID, the drop-down menu will update, allowing the user to choose an HDMI Out to copy EDID values. Select one of the four HDMI Outs and click the COPY button to apply (this replaces the APPLY button).
4	APPLY	This button applies the settings to the HDMI Input. <b>NOTE:</b> This button will change to COPY when selecting USER1, USER2, or USER3.
5	Signal	Shows the status of the HDMI Input. Green indicates the HDMI input has been detected; red indicates the HDMI connection or device has not been detected.

## Video Output Settings

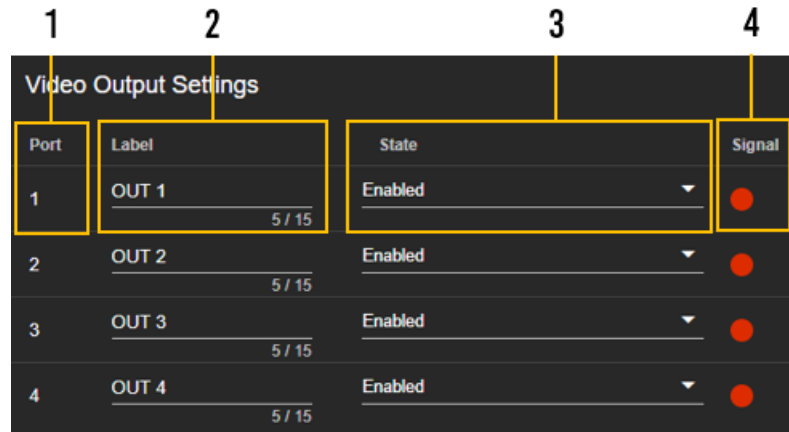

- 
- |   |               |   |
|---|---------------|---|
| 1 | <b>Port</b>   | Indicates the HDMI output port number.  |
| 2 | <b>Label</b>  | Select the text field to enter a custom name for the output. <i>(Limited to 15 characters)</i>  |
| 3 | <b>State</b>  | Use the drop-down to turn the HDMI output on or off.  |
| 4 | <b>Signal</b> | Shows the status of the HDMI Output. Green indicates the HDMI output has been detected, and red indicates the HDMI output connection or device has not been detected. |
-

# System

## IP Settings

IP Settings

- Host Name AC-FRESCO-4X
- Model Name AC-FRESCO-4X
- Serial Number 120824051100005
- MAC Address 18:8A:6A:02:74:0D
- IP assignment Automati...
- IP Address 192.168.003.088
- Subnet Mask 255.255.252.000
- Gateway 192.168.001.001
- Primary DNS 192.168.1.1
- Secondary DNS 8.8.8.8

When the IP Assignment is set to Automatic, these will be assigned by a DHCP reservation from the router, or they can be manually entered when the *IP Assignment* is set to *Manual*.

Select the *Apply* button when manually entering the *IP Assignment*, *IP Address*, *Subnet Mask*, *Gateway*, *Primary DNS*, and *Secondary DNS* for changes to take effect.

1	Host Name	Select the text field to enter a custom name for the unit. The default shows its model number.
2	Model Name	Shows the AVPro Edge model number.
3	Serial Number	Shows the unique serial number.
4	MAC Address	Shows the unique MAC address.
5	IP Assignment	Select the dropdown menu to set the unit's IP mode to <i>DHCP</i> (default) or <i>Manual (Static IP)</i> , then select the <i>Apply</i> button.
6	IP Address	Shows the IP address.
7	Subnet Mask	Shows the subnet mask.
8	Gateway	Shows the default gateway.
9	Primary DNS	Shows the primary domain name server.
10	Secondary DNS	Shows the secondary domain name server.

## IP Control

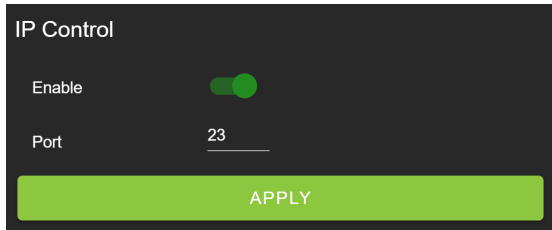

- |   |               |  |
|---|---------------|--|
| 1 | <b>Enable</b> | Select the toggle switch to turn IP/TCP control on or off.                   |
| 2 | <b>Port</b>   | Select the text field to set the Telnet port. The default is Telnet port 23. |

## Admin Web Interface



Select the *Secure* toggle switch to enable (green) or to turn off (red). When enabled, the username and password can be changed.

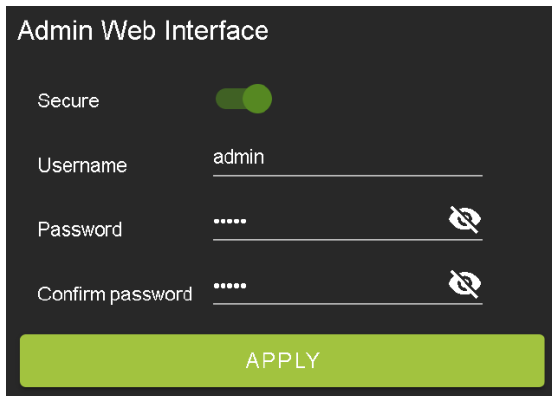

With the *Admin Web Interface* enabled, the only menu accessible on the Web UI will be the **Video Wall** tab page. The rest of the settings will require the *Admin* login.

Default username: *admin*

Default password: *admin*

## User Web Interface

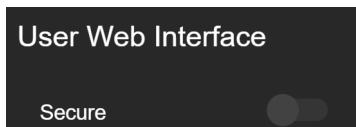

Select the *Secure* toggle switch to enable (green) or turn off (grey). When enabled, the username and password can be changed.

 **NOTE:** The *Admin Web Interface* must be enabled before changing this setting.

User Web Interface

Secure

Username

Password

Confirm password

APPLY

With the *Admin* and *User Web Interfaces* enabled, the Web UI menus are inaccessible without first logging in.

After logging in with *User* credentials, the only menu accessible on the Web UI will be the **Video Wall** tab page. The rest of the settings will require the *Admin* login.

Default username: *user*

Default password: *user123*

## Hardware

MCU	Version
MAIN MCU	0.22
NET MCU	1.04
MAIN FPGA	3.16
SPHE1 AUD	1.60
SPHE2 AUD	1.60

UPDATE FIRMWARE FACTORY RESET REBOOT

This section shows the unit's current firmware versions and provides options for updating firmware, factory resetting, and rebooting the unit.

## Cloud Services and Firmware Updates

*Cloud Services* allows OTA (Over-the-Air) firmware updates on the unit. This allows the unit to search the Cloud for the latest firmware versions and enable third-party remote management services. If the *Cloud Services* setting is turned off, the unit will opt out of any previously enabled services and cannot access OTA firmware updates.

**NOTE:** When updating firmware, some settings and configurations may revert to their original factory default settings and may need to be re-applied after the updates are complete. It is always recommended that settings and configurations are backed up before updating firmware.

- 1 Enter the unit IP address into a Chrome or Edge web browser to access the Web UI.

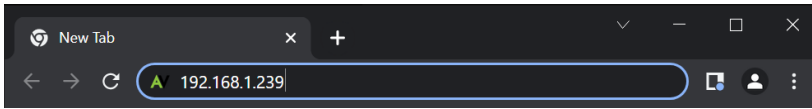

- 2 Navigate to the *System* tab page.

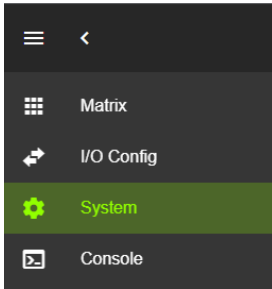

- 3 Review the *Privacy Policy* and *Terms of Use* in the Cloud Services section, then check both boxes and select the *Enable Cloud Services* toggle setting.

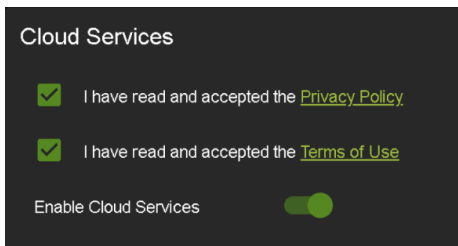

**IMPORTANT:** This is required for the unit to perform OTA firmware updates.

- 4 In the *Hardware* section, select the *Update Firmware* button. A new dialog box will open.

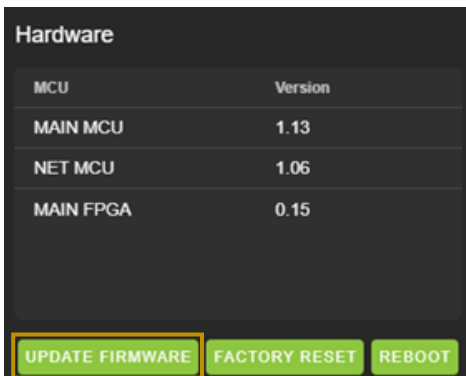

- 5 In the *Update Firmware* dialog box, select *Check for Update*. The unit will now check the Cloud for available firmware updates.

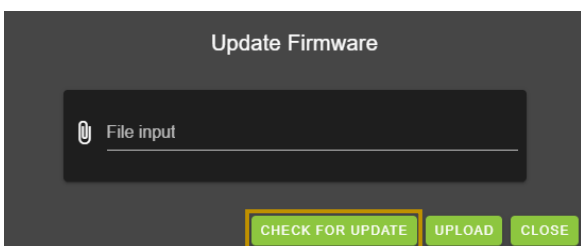

- 6 If the current firmware version is the latest, a notification window will prompt the message “No update available!” at the top of the page. Select the *Close* button.



- 7 If a newer firmware version is detected from the Cloud, a notification window will prompt the message “New firmware update is available!”. Select the *Update* button.



- 8 A new firmware file will automatically populate into the *File input* field from the Cloud. Select the *Upload* button.

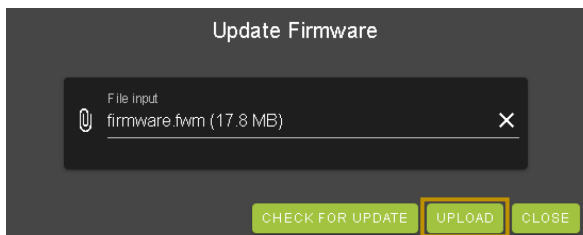

- 9 From this screen, a newer firmware version is displayed before installation. Select the *Upgrade* button. The unit will then begin installing the latest firmware version. **DO NOT** refresh the webpage or power off the unit during the update!

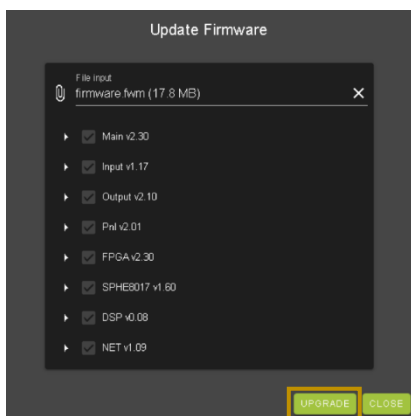

- 10 Once the progress bar reaches 100%, select the *Close* button. Once the firmware updates are complete, the unit will automatically reboot. After the unit reboots, refresh the webpage.

# Console

The Web UI features a built-in command console, allowing API commands to be directly sent to the unit.

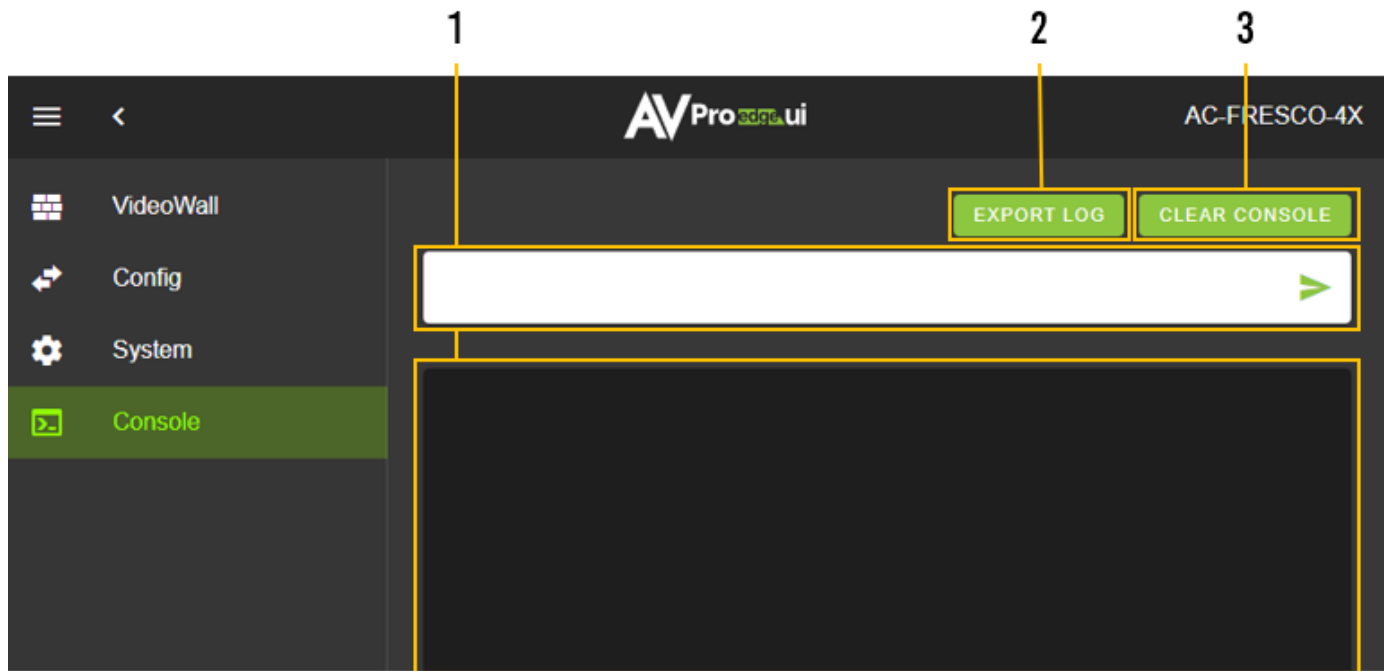

1	<b>Text Field</b>	Enter API commands into this field. System events generated by the unit will be recorded continuously while the <i>Console</i> tab page is open within the Web UI.
2	<b>Export Log</b>	Select to download a .txt file of the information recorded by the console log. The console log only records unit information when the Web UI is opened to the <i>Console</i> tab page and does not record or store information internally.
3	<b>Clear Console</b>	Select to clear the information recorded in the console log.

## Command-List

Command	Action
H	Help
STA	Show Global System Status
SET RBT	Reboot Device
SET RST	Reset to Factory Defaults
SET ADDR xx	Set System Address to xx {xx = [00~99] (00 = Single)}
SET BAUDR x	Set System BaudRate to x {x = [0~5] (0 = 9600, 1 = 14400, etc.)}
SET INx RST	Set Input Port Reset {x = [0~1] (0 = ALL)}
SET OUTx RST	Set Output Port Reset {x = [0~4] (0 = ALL)}
SET LCD ON Tx	Set LCD Remain On Time {x = [0~3] (0 = Always ON, 1 = 15, etc.)}
SET KEY LOCK ON/OFF	Set Key Lock On/Off
SET FAN SPEED x	Set Fan Speed {x = [0~6]}
GET ADDR	Get System Address
GET STA	Get System System Status
GET BAUDR	Get System BaudRate Status
GET INx SIG STA	Get Input x Signal Status {x = [0~1] (0 = ALL)}
GET OUTx HPD	Get HDMI Output x HPD Status {x = [0~4] (0 = ALL)}
GET LCD ON T	Get LCD Remain On Time
GET KEY LOCK	Get Key Lock Status
GET FAN SPEED	Get Fan Speed Value
GET HW REV	Get Hardware Revision
<b>Output Setup Commands:</b>	
SET OUTx VSFM y	Set Output x Video Scale Format y {x = [0~4] (0 = ALL), y = [0~2] (0: Auto, 1: Force 4K, 2: Force 1080P)}
SET OUTx STREAM ON/OFF	Set Output x STREAM ON/OFF {x = [0~4] (0 = ALL)}
GET OUTx VSFM	Get Output x Video Scale Format Status {x = [0~4] (0 = ALL)}
GET OUTx STREAM	Get Output x Stream ON/OFF Status {x = [0~4] (0 = ALL)}
GET OUTx EDID DATA	Get Output x EDID DATA {x = [1~4]}
<b>Input Setup Commands:</b>	
SET INx EDID y	Set Input x EDID{x=[0-1](0=All), y=[0~8]}
0: FRL10G_8K_2CH_HDR	1: FRL10G_8K_6CH_HDR                      2: FRL10G_8K_8CH_HDR
3: FRL12G_8K_2CH_HDR	4: FRL12G_8K_6CH_HDR                      5: FRL12G_8K_8CH_HDR
6: USER1_EDID	7: USER2_EDID                                  8: USER3_EDID
SET INx EDID CY OUTy	Copy Output y EDID To Input x (USER1 BUF){x = [0-1] (0 = All), y = [1-4]}
SET INx EDID Uy DATAz	Write EDID To User y Buffer of Input x {x = [0-1] (0 = All), y = [1-3], z = [EDID Data]}
GET INx EDID	Get Input x EDID Index {x = [0-1] (0 = All)}
GET INx EDID y DATA	Get Input x EDID y Data {x = [1], y = [0~8]}
<b>Output Video Captor Commands:</b>	
SET OUTx AOST h.v	Set Output x Video Area Offset h.v{x=[0-4](0=All), h=[0-3840](Hori offset of areas),v=[0-2160](Vert offset of areas)}
SET OUTx VSCA h.v	Set Output x Video horizontal and/or vertical scaling of each active area h.v {x=[0-4](0=All), if x=1(output1) h=[960-7680] v=[540-4320],if x!=1 h=[960-3840] (Horizontal output size of areas),v=[540-2160](Vertical output size of areas)} if x=1(output1) h=7680 v=4320, output will be displayed in full screen, supported only by Output1
SET OUTx ACDR h.v	Set Output x Video Area Scandir h.v{x=[0-4](0=All),h=[0-1](Hori scan direction of areas, 0: Normal, 1: Reverse),v=[0-1](Vert scan direction of four areas,0: Normal, 1: Reverse)}
GET OUTx AOST	Get Output x Video Area Offset Status{x=[0-4](0=All)}

GET OUTx VSCA	Set Output x Video horizontal and/or vertical scaling of each active area Status{x=[0-4](0=All)}
GET OUTx ACDR	Get Output x Video Area Scandir Status{x=[0-4](0=All)}
<b>Network Setup Command: ( xxx=[000-255], zzzz=[0001~9999]</b>	
SET RIP xxx.xxx.xxx.xxx	Set Route IP Address to xxx.xxx.xxx.xxx
SET HIP xxx.xxx.xxx.xxx	Set Host IP Address to xxx.xxx.xxx.xxx
SET NMK xxx.xxx.xxx.xxx	Set Net Mask to xxx.xxx.xxx.xxx
SET TIP zzzz	Set TCP/IP Port to zzzz
SET DHCP y	Set DHCP {y = [0~1] (0 = Disable, 1 = Enable)}
GET RIP	Get Route IP Address
GET HIP	Get Host IP Address
GET NMK	Get Net Mask
GET TIP	Get TCP/IP Port
GET DHCP	Get DHCP Status
GET MAC	Get MAC Address

# Troubleshooting

- Verify Power - Ensure the power supply is connected correctly and on an active circuit.
- Verify Connections - Ensure all cables are securely connected and properly terminated.
- Verify Current Versions - Ensure that any firmware/software/driver updates are available for the devices.
- No Sound - Verify the signal being sent is compatible with the connected devices in the signal chain. Ensure the device's volume level is adjusted correctly and not set to mute.

# Maintenance

Please observe the following instructions to ensure the reliable operation of this product and protect the safety of any person using or handling this device while powered.

- Use the provided power supply. If an alternate supply is required, check its voltage and polarity to ensure that it has sufficient power to supply the device.
- Do not operate these products outside the specified temperature and humidity range in the above specifications.
- Ensure there is adequate ventilation to allow this product to operate efficiently.
- Equipment repair should only be carried out by qualified professionals, as these products contain sensitive components easily damaged by mistreatment.
- Only use this product in a dry environment. Do not allow any liquids or harmful chemicals to come into contact with these products.
- Clean this unit with a soft, dry cloth. Never use alcohol, paint thinner, or benzene for cleaning.

# Damage Requiring Service

The unit should be serviced by qualified service personnel if:

- The DC power supply cord or AC adapter has been damaged
- Objects or liquids have gotten into the unit
- The unit has been exposed to rain
- The unit does not operate normally or exhibits a marked change in performance
- The unit has been dropped, or the housing damaged

# Support

If you experience any problems while using this product, refer to the Troubleshooting section of this manual before contacting Technical Support. When calling, the following information should be provided:

- Product name and model number
- Product serial number
- Details of the issue and any conditions under which the issue is occurring
- Clean this unit with a soft, dry cloth. Never use alcohol, paint thinner, or benzene to clean this unit.

# Warranty

## The Basics

AVPro Edge warranties its products purchased from Authorized AVPro Edge Resellers or direct purchases. Products are guaranteed free from manufacturing defects and in sound physical and electronic condition.

AVPro Edge has developed a warranty that anyone can support. We wanted to remove all the “red tape” from a warranty and make it simple. Our 10-year NO-BS warranty hinges on three elements:

- If you are having trouble, call us. We will attempt to troubleshoot your issue over the phone.
- If it's broken, we will replace it in advance on our dime and cover the return shipping. Repair is an option, too, but that is YOUR call.
- We know you know what you are doing. We will not make you go through unnecessary steps to troubleshoot an extender...

## Coverage Details

AVPro Edge will replace or repair (at the customer's choice) any defective product within the warranty period. If the product is out of stock or on backorder, it can be replaced with a comparable product of equal value/feature set (if available) or repaired.

Your warranty begins upon receipt of the product (as confirmed by the shipping firm's tracking). If tracking information is unavailable, the warranty will commence 30 ARO (After Receipt of Order). The coverage continues for 10 years.

## Red Tape

AVPro Edge is not responsible for untraceable purchases or those made outside an authorized channel.

If we conclude that a product or serial number has been tampered with, as identified by the warranty seal or physical examination, the warranty will be void. Additionally, excessive physical damage (beyond normal wear and tear) may result in the warranty being voided or prorated based on the extent of the damage, as examined by an AVPro Edge representative.

Damage caused by “acts of God” is not covered. These can include natural disasters, power surges, storms, earthquakes, tornadoes, sinkholes, typhoons, tidal waves, hurricanes, or any other uncontrollable event related to nature.

Damage caused by incorrect installation will not be covered. Examples include an incorrect power supply, inadequate cooling, improper cabling, inadequate protection, and static discharge.

The Authorized AVPro Edge Reseller will service products installed or sold by a third party to AVPro Edge. The warranty does not include accessories (IR Cables, RS-232, Power Supplies, etc.). We will make acceptable efforts to source and supply replacements for defective accessories at a discounted rate as needed.

## Obtaining an RMA

Dealers, Re-sellers, and Installers can request an RMA from the AVPro Edge Tech Support Rep or their Sales Engineer.

You may also email [support@avproedge.com](mailto:support@avproedge.com) or fill out the general contact form at [avproedge.com/contact](http://avproedge.com/contact)

End users may not request an RMA directly from AVPro Edge and will be referred back to the Dealer, Re-seller, or Installer.

## Shipping

For the USA (not including Alaska and Hawaii). Shipping is covered on advanced replacements for FedEx Ground (some expressed exceptions may apply). Defective product return shipping is covered by AVPro Edge using an emailed return label. Items must be returned within 30 days of receipt of the replacement product; after 30 days, the customer will be billed. Other return shipping methods will not be covered.

For International (and Alaska and Hawaii) returns, the returnee will be responsible for the shipping costs. Once the unit is scanned for return shipping, AVPro Edge will ship the new unit for replacement.

## Limitation on Liability

AVPro Global Holdings LLC's maximum liability under this limited warranty shall not exceed the actual purchase price paid for the product. AVPro Global Holdings LLC is not responsible for direct, special, incidental, or consequential damages resulting from any breach of warranty or condition or under any other legal theory to the maximum extent permitted by law. Taxes, Duties, VAT, and freight forwarding service charges are not covered or paid for by this warranty.

This warranty does not cover obsolescence or incompatibility with newly invented technologies (after the product's manufacture).

Obsolescence is defined as:

"Peripherals are rendered obsolete when current technology does not support product repair or re-manufacture. Obsolete products cannot be re-manufactured because advanced technologies supersede original product manufacturer capabilities. Product redevelopment is not an option because of performance, price, and functionality issues."

Discontinued or out-of-production items will be credited at fair market value toward a current product of equal or comparable capabilities and cost. AVPro Edge determines fair market value.

## Exclusive Remedy

This limited warranty and the remedies above are exclusive to the maximum extent law permits, instead of all other warranties, remedies, and conditions, whether oral or written, express or implied. To the maximum extent permitted by law, AVPro Global Holdings LLC expressly disclaims any implied warranties, including, without limitation, warranties of merchantability and fitness for a particular purpose. If AVPro Global Holdings LLC cannot lawfully disclaim or exclude implied warranties under applicable law, all implied warranties covering this product, including merchantability and fitness for a particular purpose, shall apply to this product as provided under applicable law.

This warranty supersedes all other warranties, remedies, and conditions, whether oral or written, express or implied.